

# SPIROGRAPH











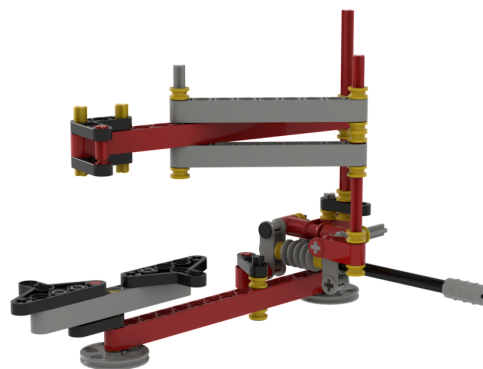

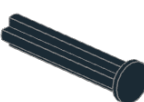

Principles : 

Level : ★★☆☆

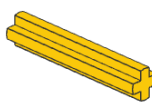
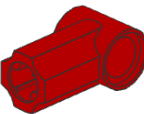
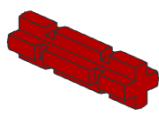
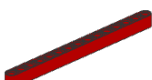
Steps : 8

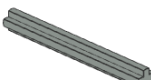
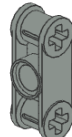
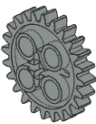
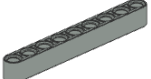
Bricks : 65

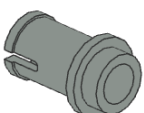
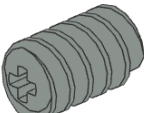
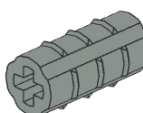

2 x 	2 x 	2 x 	1 x 	3 x 	21 x 	4 x 
3 x 	4 x 	2 x 	2 x 	2 x 	3 x 	2 x 
1 x 	3 x 	2 x 	1 x 	1 x 	1 x 	3 x 



1

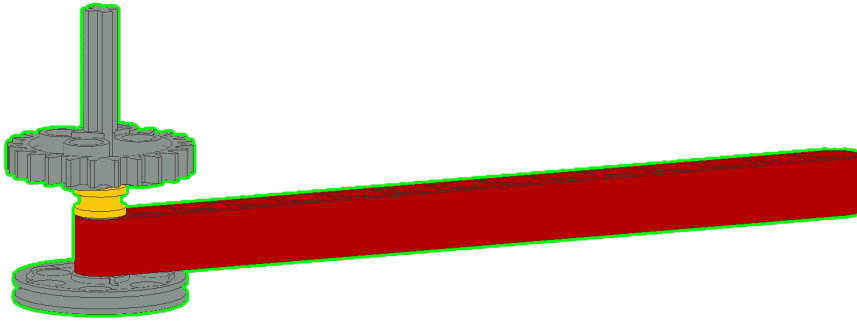
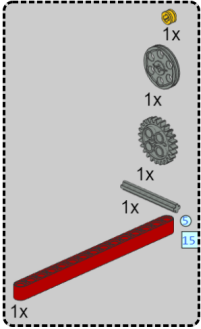



5

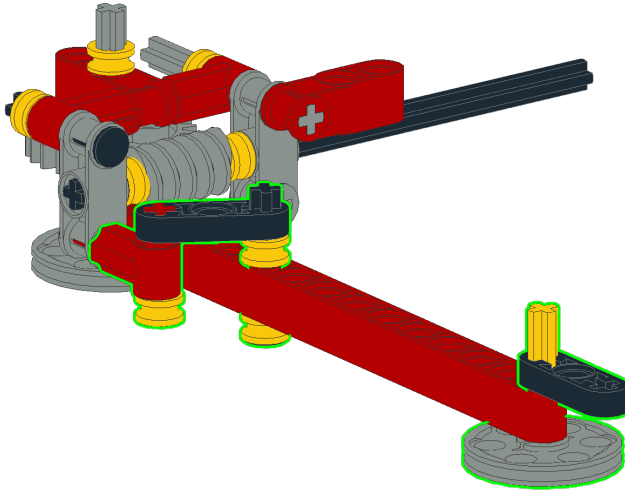
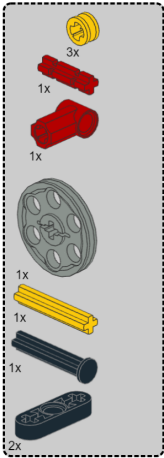

6

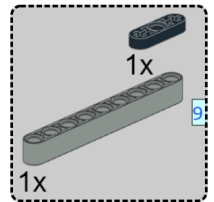
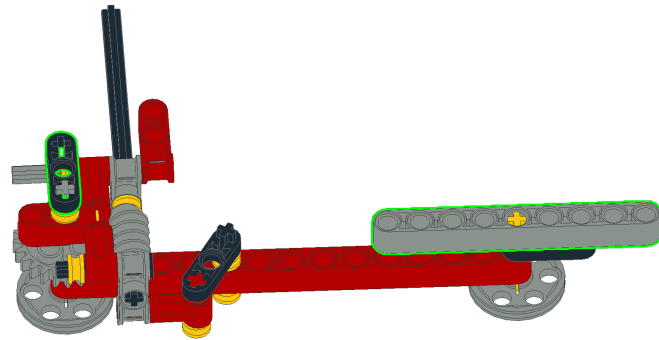

7

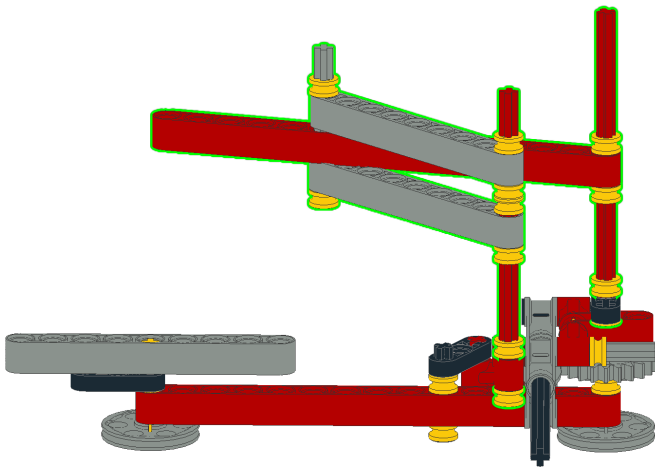
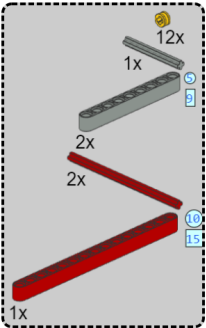

8

