

PARKING BARRIER









Principles :  

Level : ★★

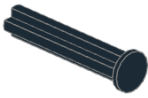
Steps : 6

Bricks : 33

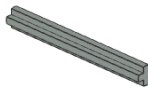
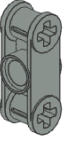
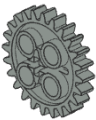
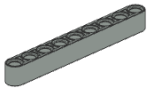
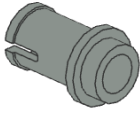
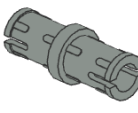
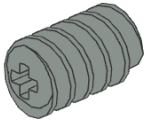
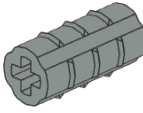

2 x 	1 x 	12 x 	2 x 	1 x 	2 x 	3 x 
2 x 	1 x 	2 x 	1 x 	2 x 	1 x 	1 x 



PARKING BARRIER ★★



1

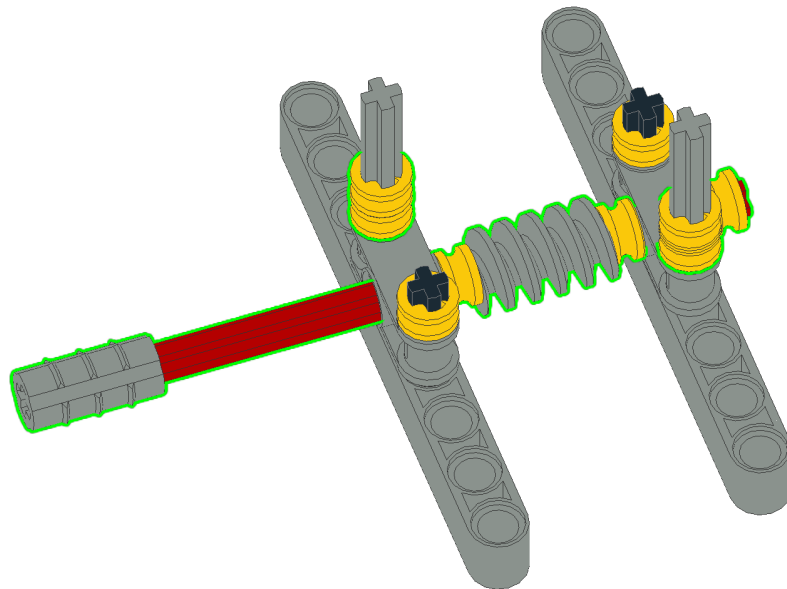
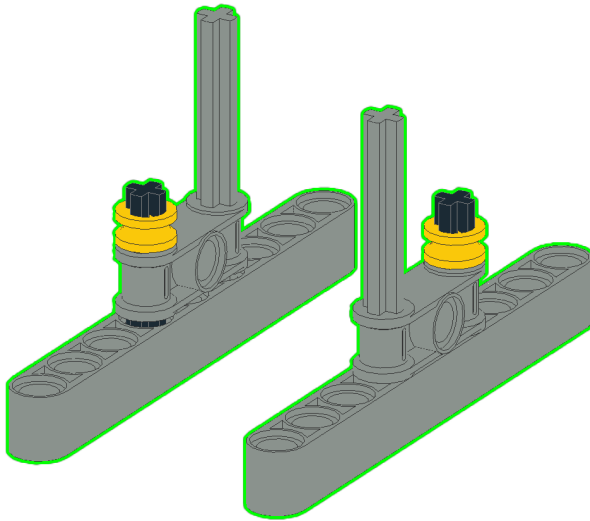
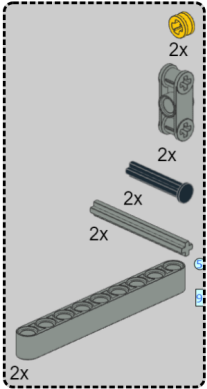

2

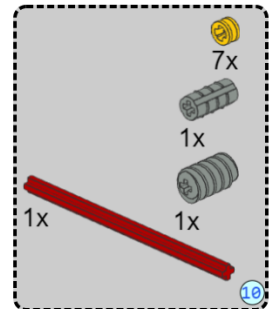

3

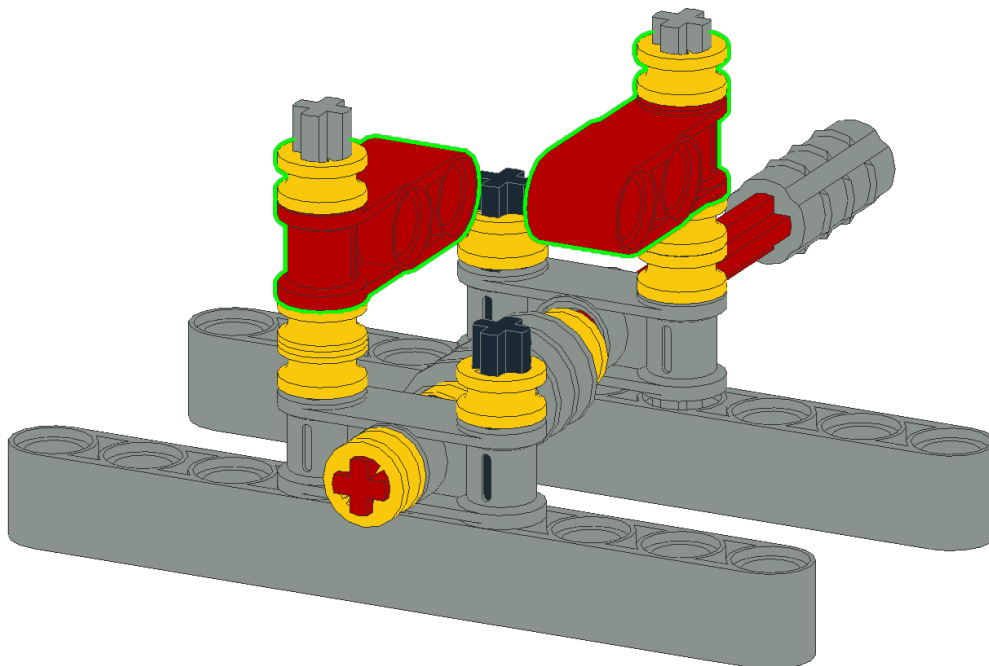
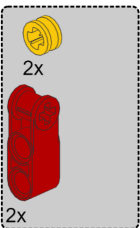



PARKING BARRIER ★★



4

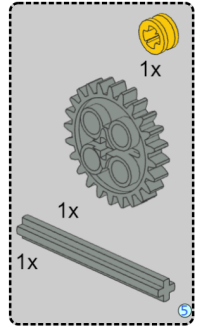
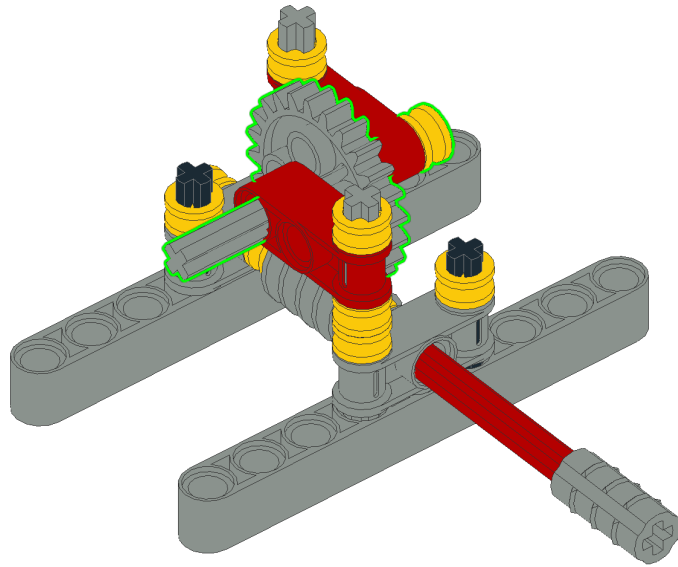

5

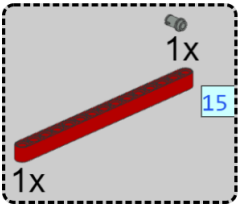
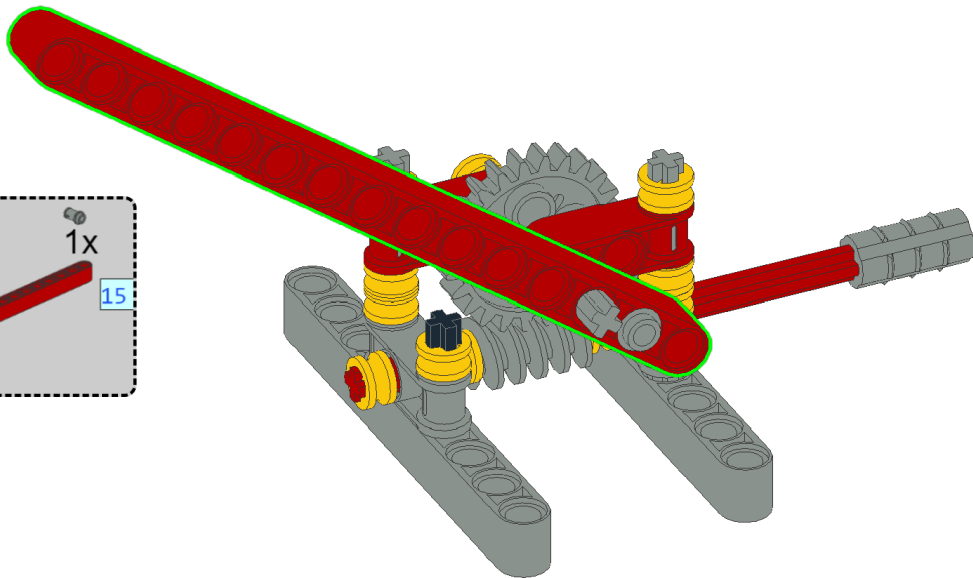

6

