

HIKING MAN













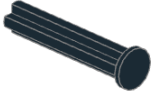
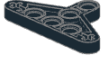

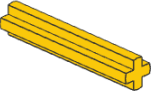
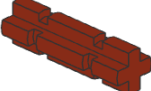

Principles :   

Level : ★★★

Steps : 7

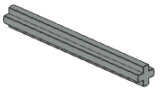
Bricks : 58

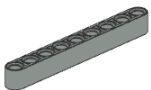

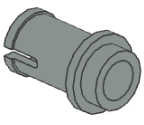
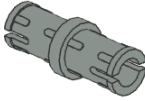
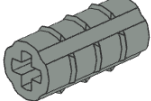
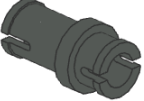
1 x 	2 x 	4 x 	2 x 	2 x 	4 x 	8 x 
1 x 	2 x 	1 x 	1 x 	3 x 	2 x 	6 x 
2 x 	4 x 	1 x 	2 x 	6 x 	1 x 	3 x 



1

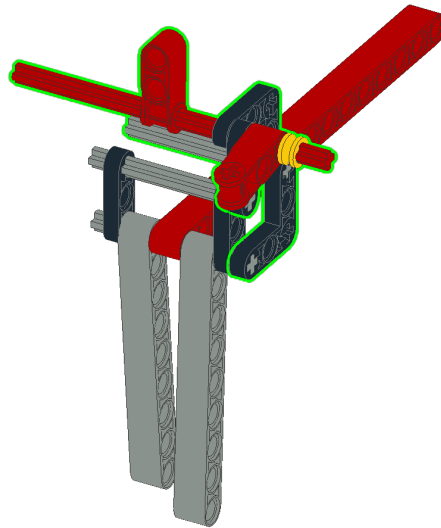
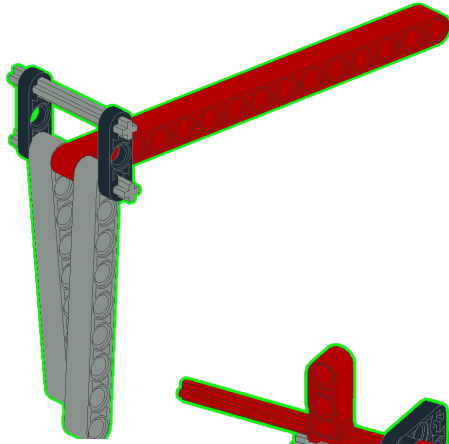
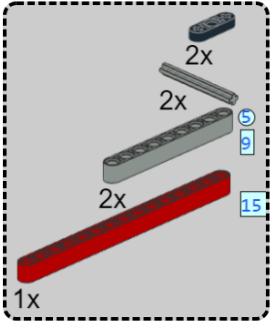

2

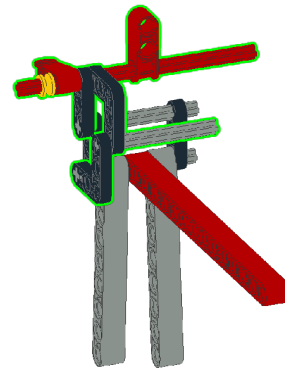
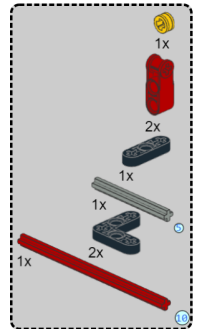

3

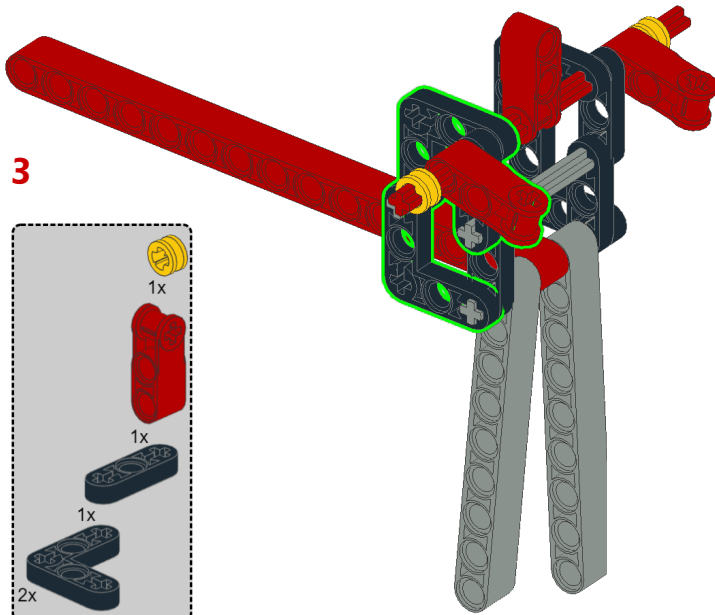
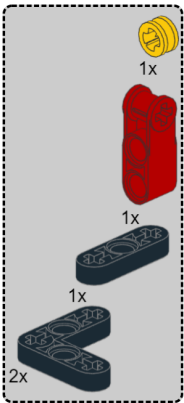

4

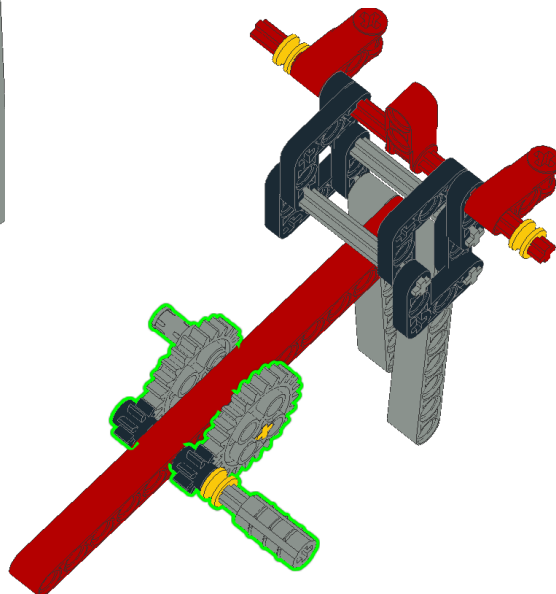
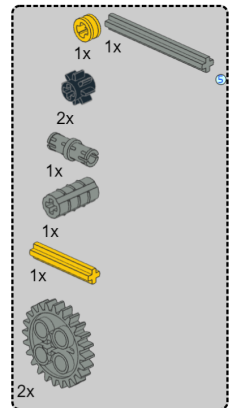



5

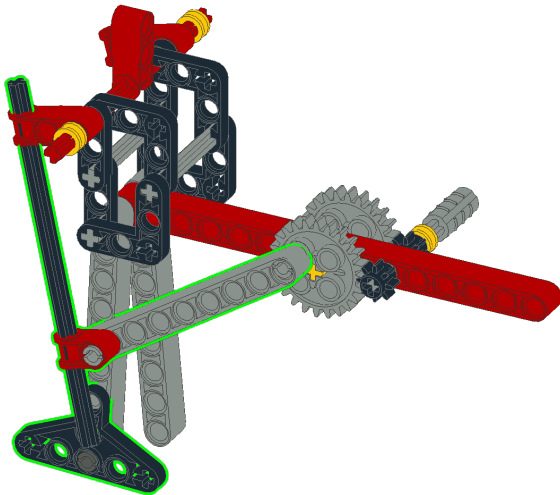
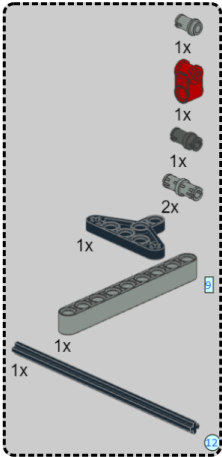

6

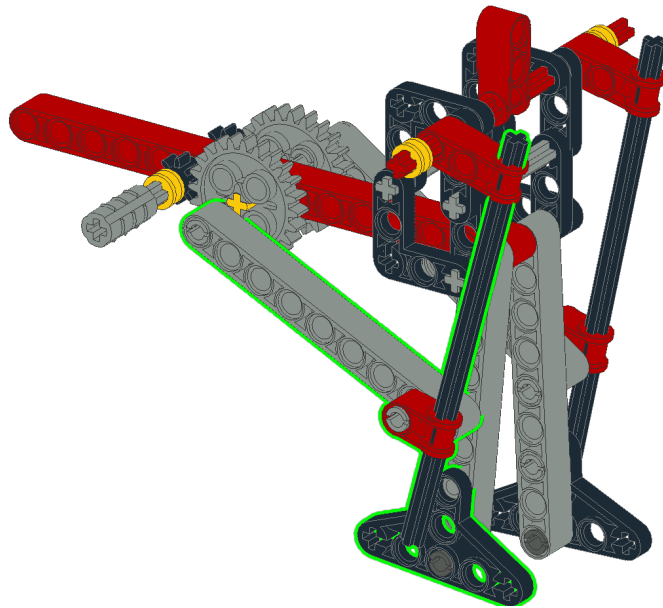
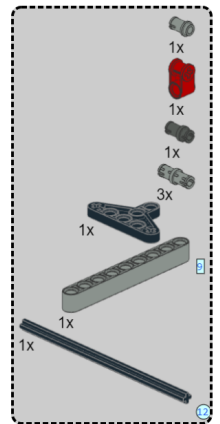

7

