

# WINDMILL





Principles : 

Level : ★★

Steps : 8

Bricks : 51

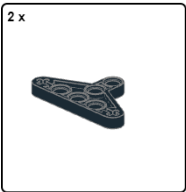
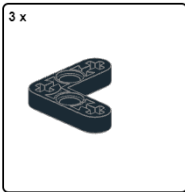

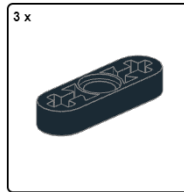
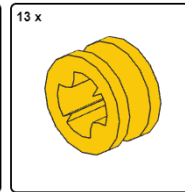
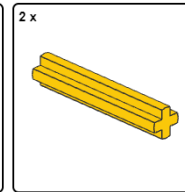
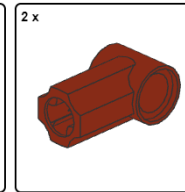
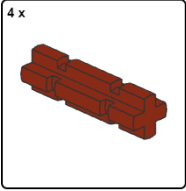
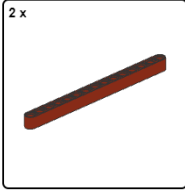
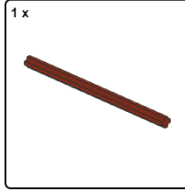
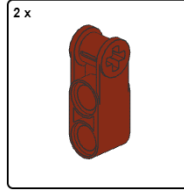
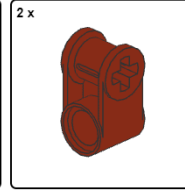
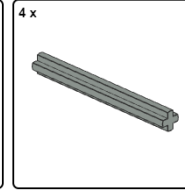
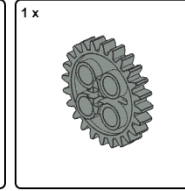
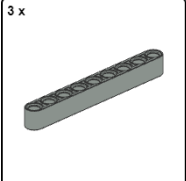
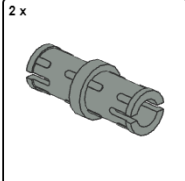
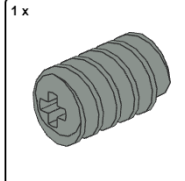
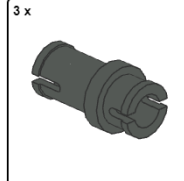
2 x 	3 x 	1 x 	3 x 	13 x 	2 x 	2 x 
4 x 	2 x 	1 x 	2 x 	2 x 	4 x 	1 x 
3 x 	2 x 	1 x 	3 x 			



# WINDMILL ★★



1

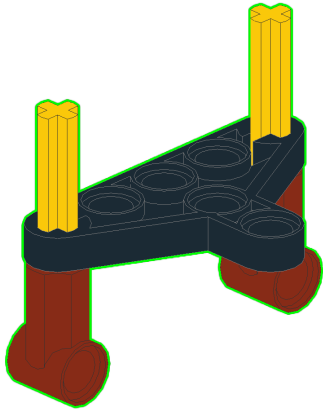
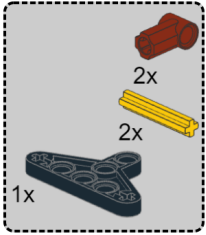

2

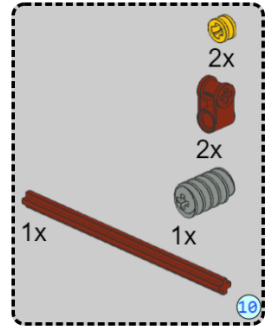
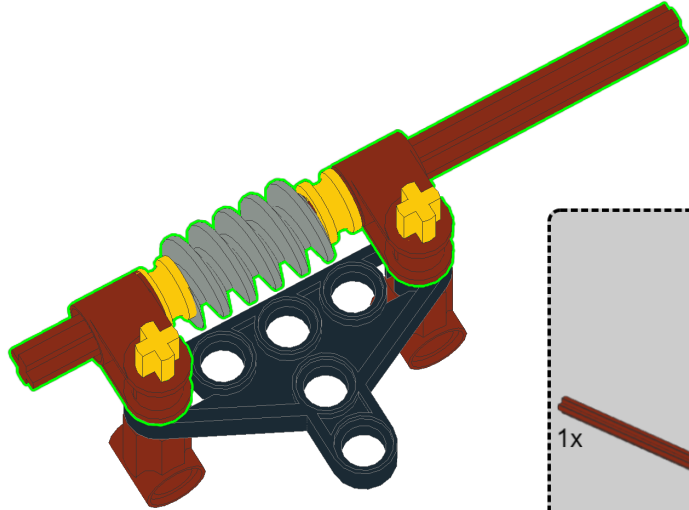

3

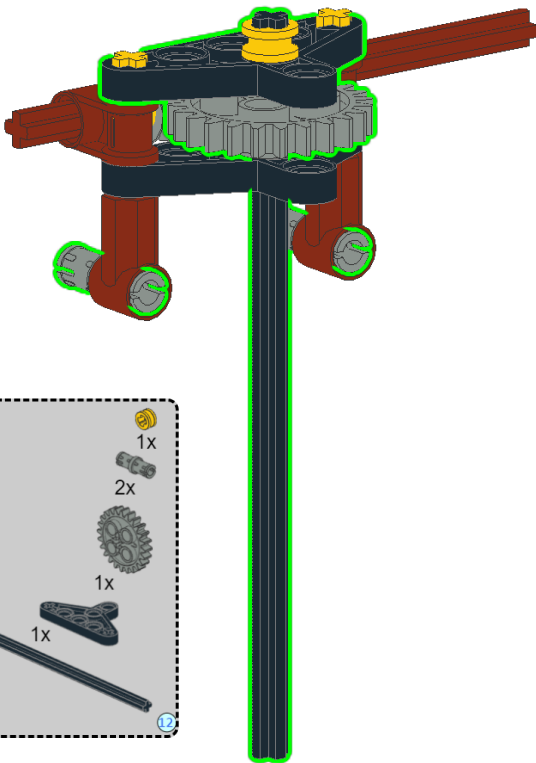
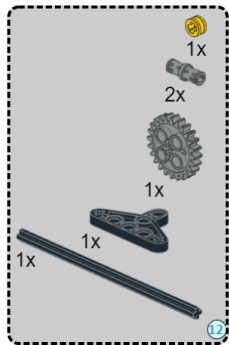

4

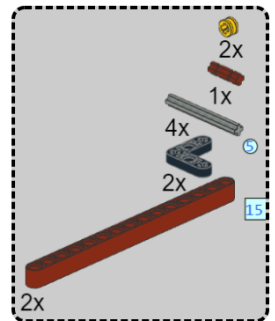
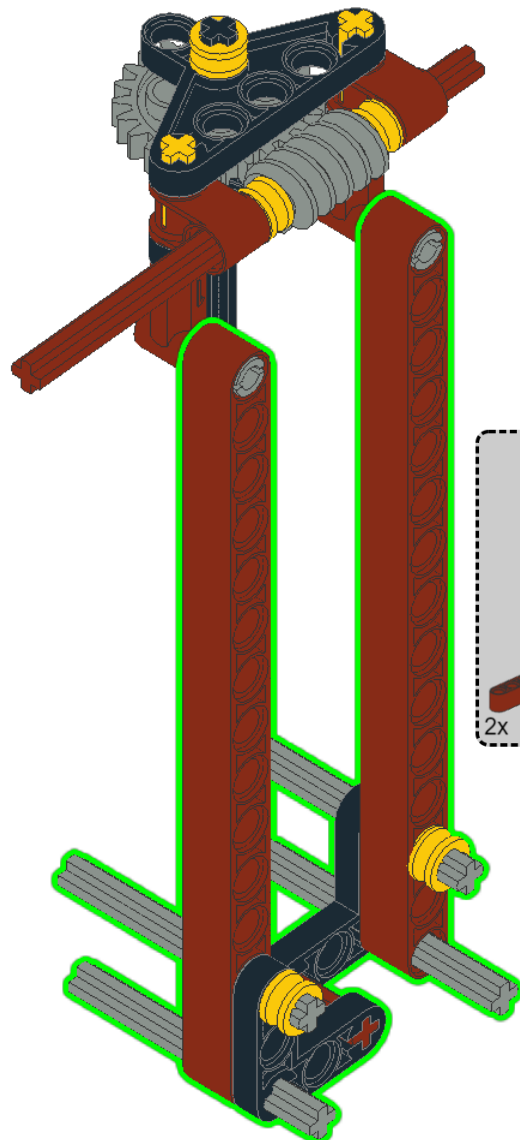



5

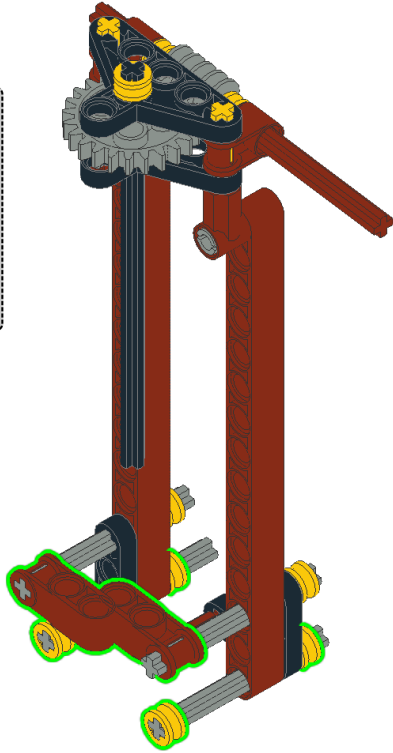
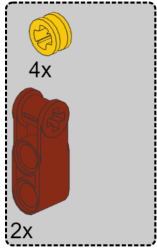

6

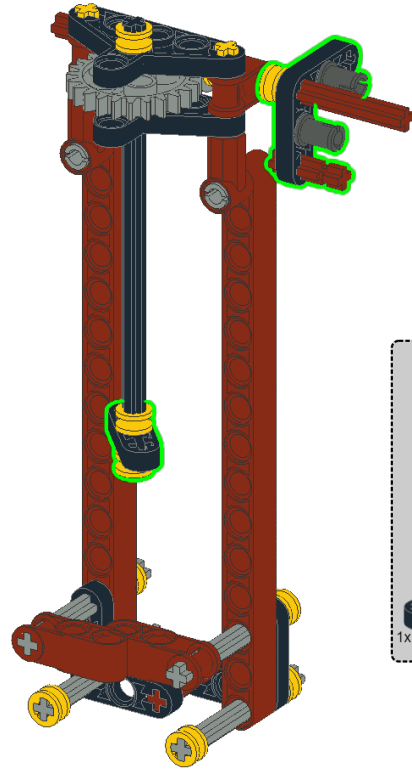
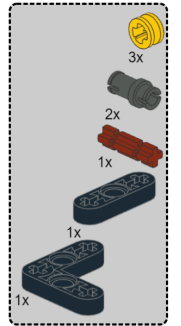

7

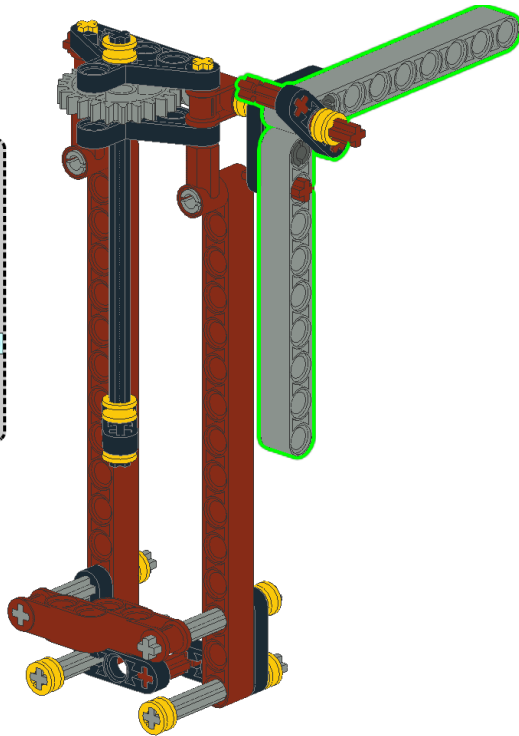
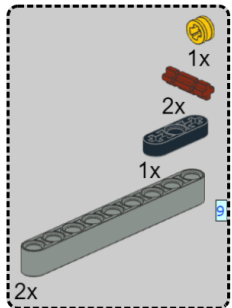

8

