



DOUBLE CAROUSEL











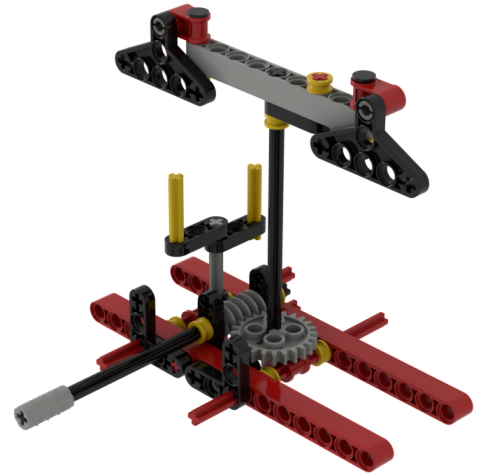

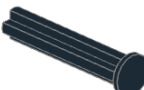

Principles :   

Level : ★★

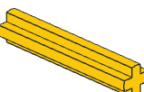
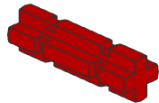
Steps : 6

Bricks : 47

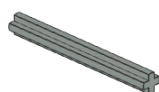
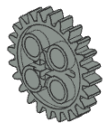
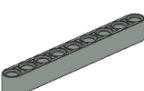
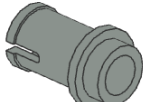
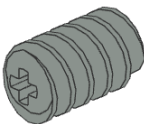
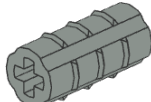

| | | | | | | |
|--|--|--|--|---|--|---|
| 2 x  | 2 x  | 4 x  | 1 x  | 2 x  | 3 x  | 10 x  |
| 2 x  | 3 x  | 2 x  | 2 x  | 4 x  | 1 x  | 1 x  |
| 1 x  | 2 x  | 1 x  | 1 x  | 3 x  | | |



DOUBLE CAROUSEL ★★



1

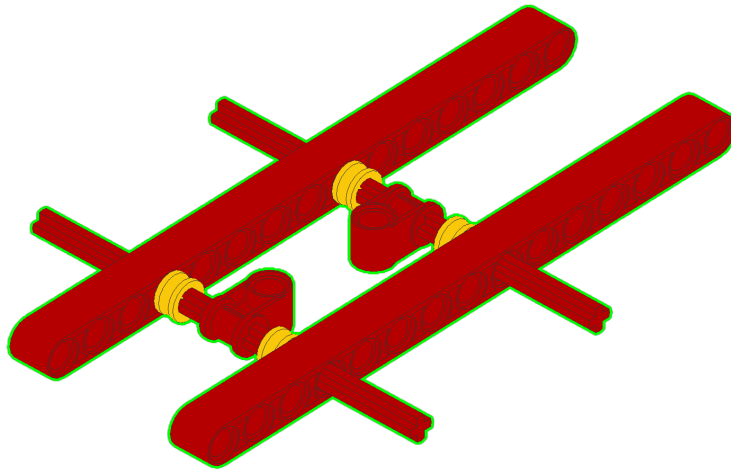
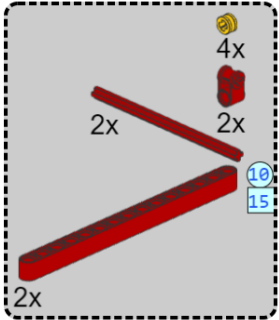

2

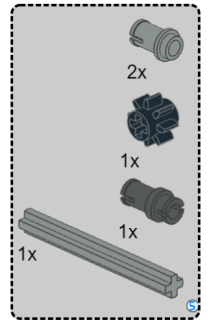
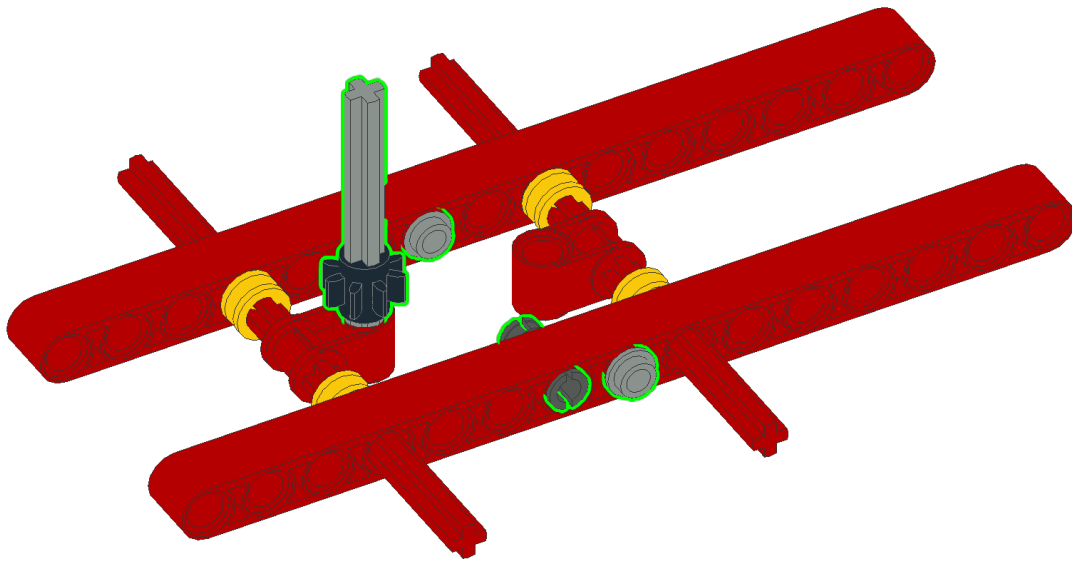

3

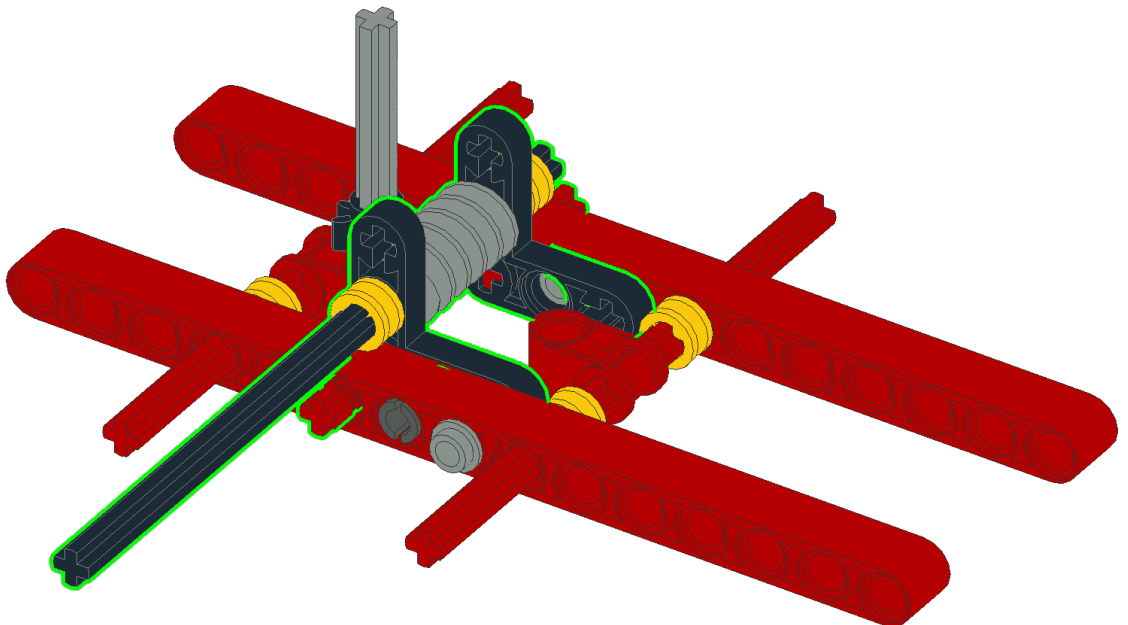
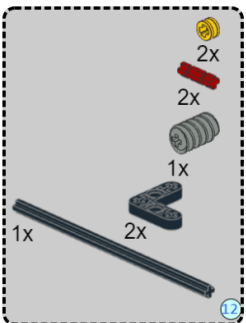



DOUBLE CAROUSEL ★★



4

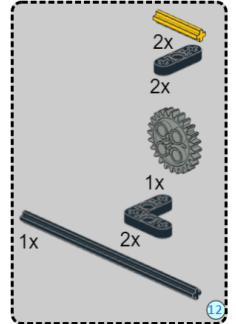
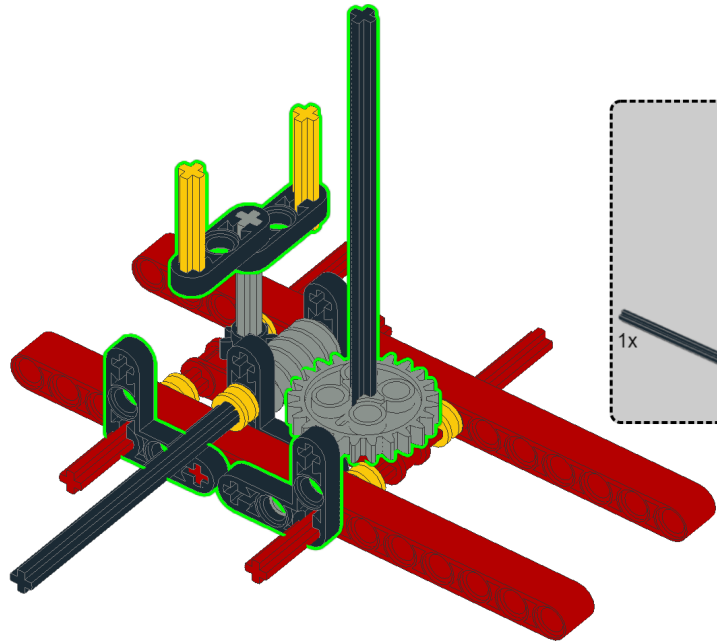

5

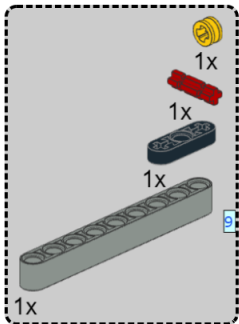
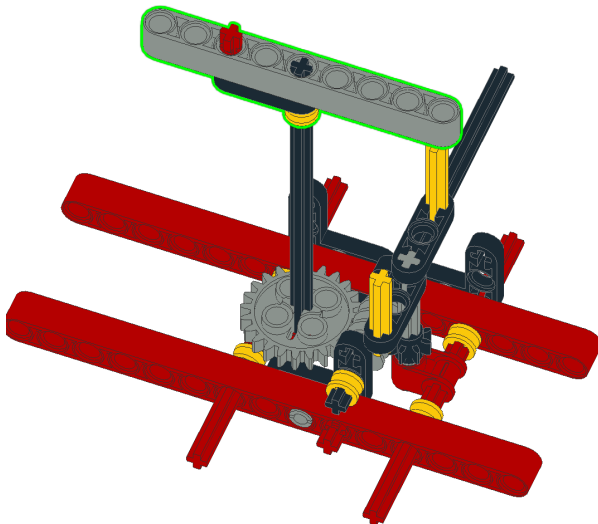

6

