

FERRIS WHEEL











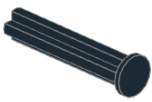
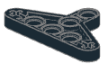

Principles :  

Level : ★★★

Steps : 9

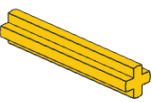
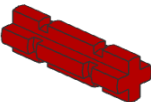
Bricks : 68

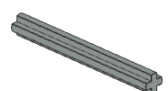
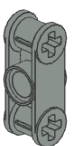
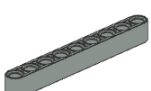
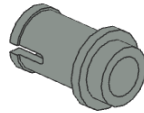
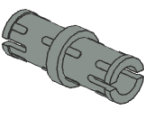
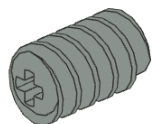
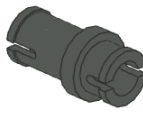

2 x 	2 x 	3 x 	1 x 	1 x 	3 x 	22 x 
2 x 	2 x 	4 x 	2 x 	2 x 	2 x 	4 x 
2 x 	4 x 	2 x 	4 x 	1 x 	3 x 	



1

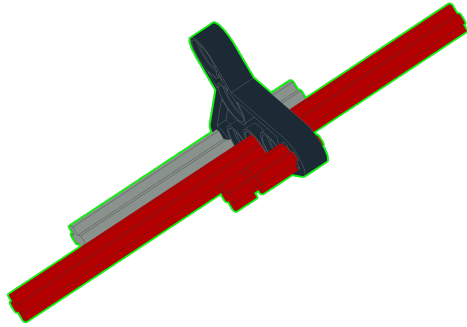

2

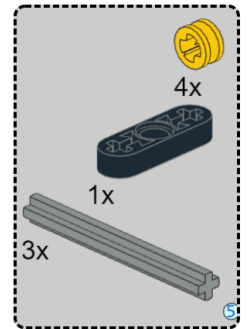
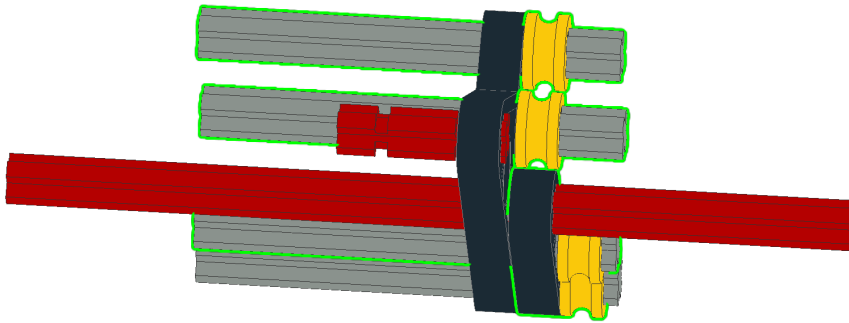

3

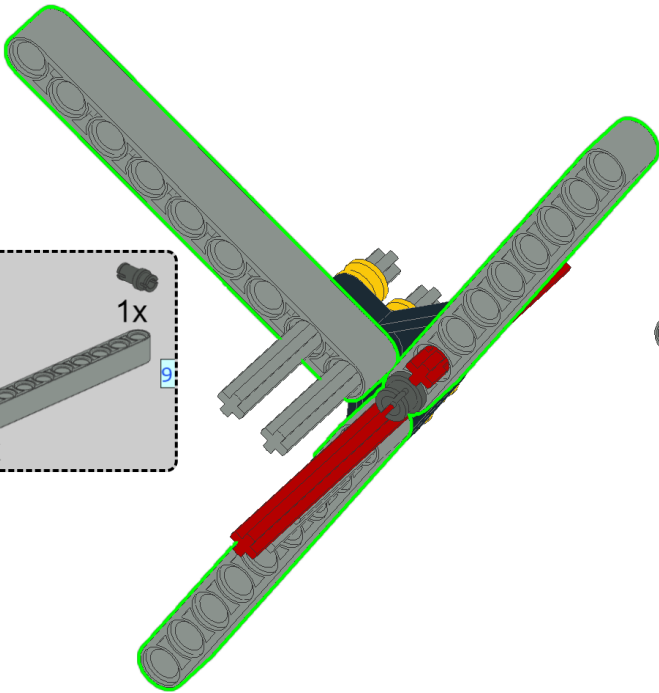
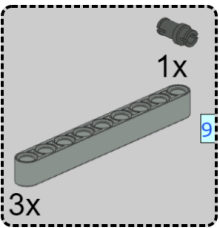

4

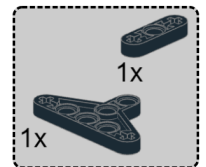
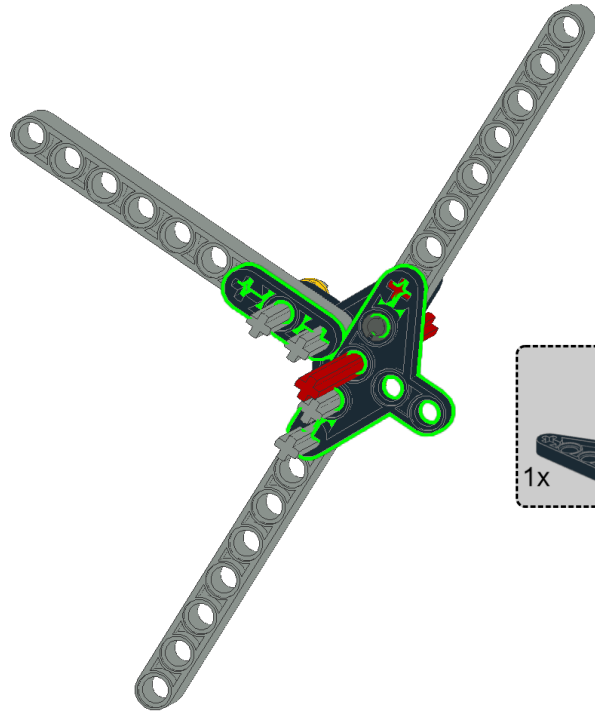



5

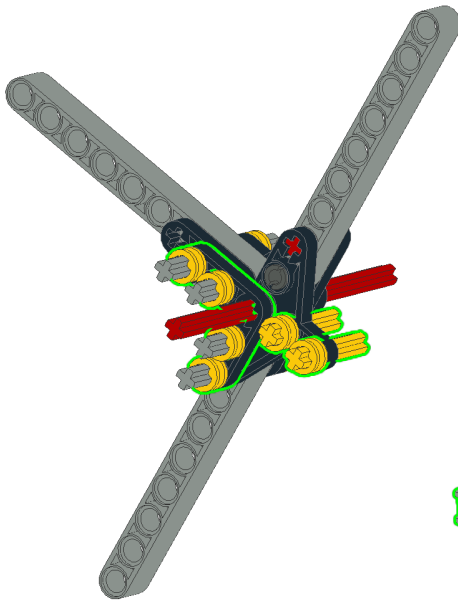
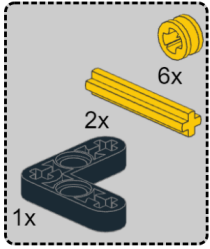

6

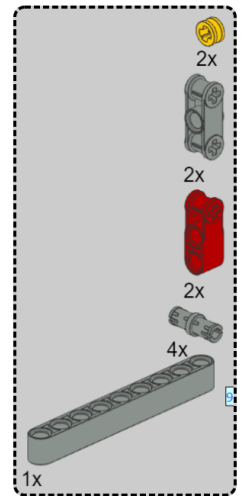
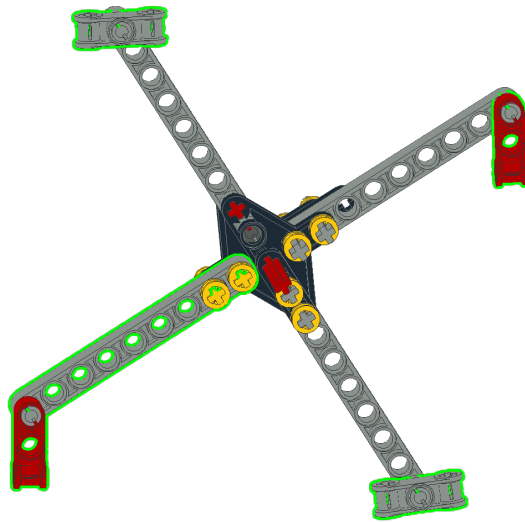

7

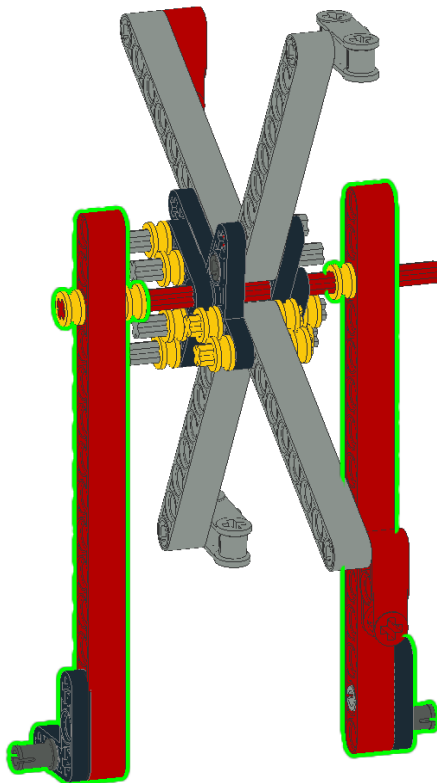
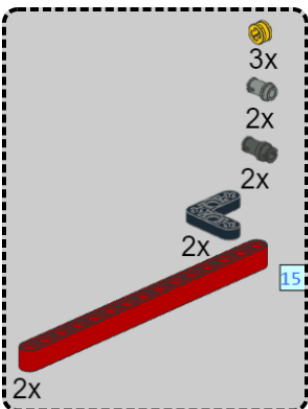



8

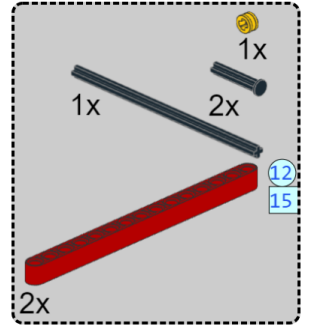
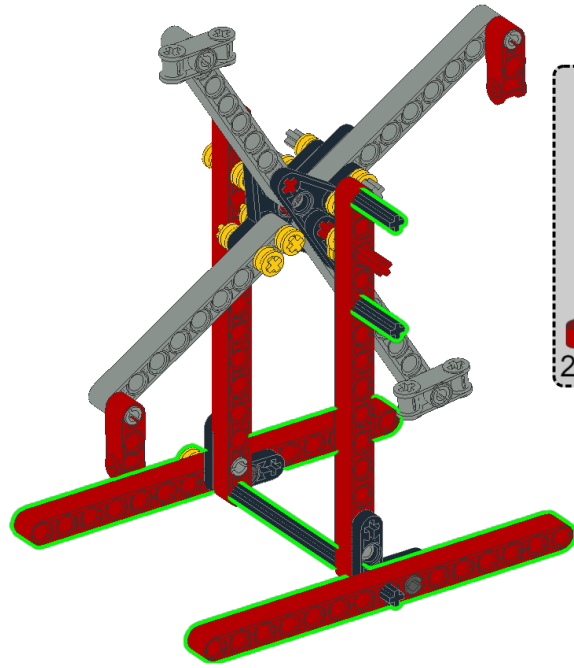

9

